

ODH.020

OXYDENT

version: 03082020.2

Dimensions are in mm, unless otherwise specified

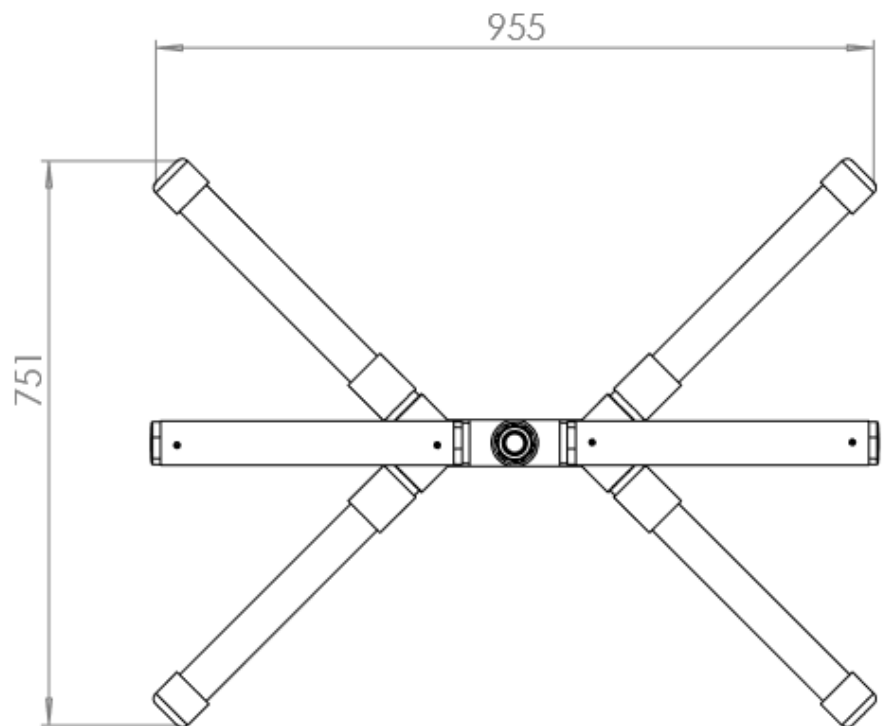
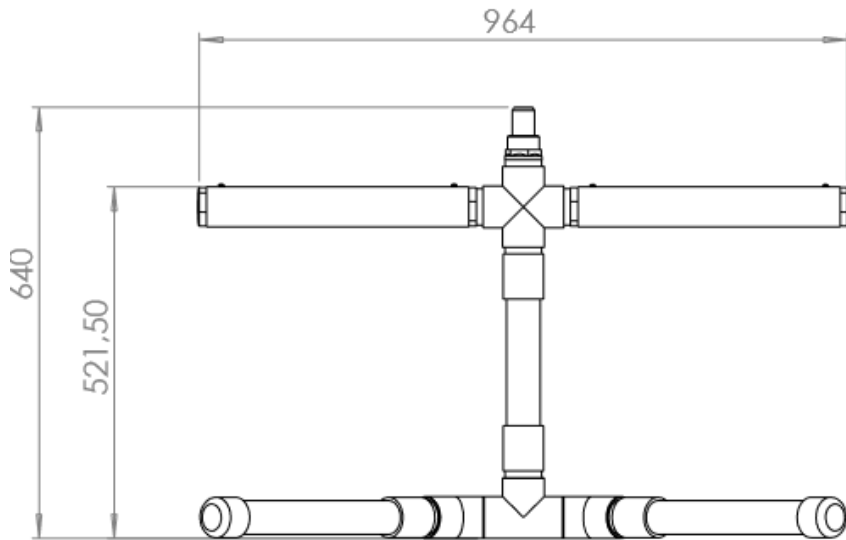

- weight **19,6 kg**
- airflow **5-20 m³/h**
- pressure loss **5-20 mbar**

